

# AGRG® EYWA® BeeSwitch Sensor Wireless Scene Switch

Installation and operation manual



# Contents

- 1. About the Manual.....4**
  - 1.1. The Term of the Manual..... 4
  - 1.2. Content and Purpose of the Document..... 4
- 2. Basic Safety Instructions.....5**
  - 2.1. Target Purpose..... 5
  - 2.2. Assembly and Installation..... 5
  - 2.3. Service and Maintenance..... 5
  - 2.4. Accessories and Spare Parts..... 5
  - 2.5. Environment Protection..... 5
- 3. Product Description.....6**
  - 3.1. Overview..... 6
  - 3.2. Mounting..... 6
  - 3.3. Operation Principle..... 7
  - 3.4. Technical Specifications..... 7
  - 3.5. What's in the Box..... 8
- 4. Preparation for Work.....9**
  - 4.1. Battery Installation..... 9
  - 4.2. Binding to Zigbee Gateway..... 9
  - 4.3. Device Configuration Using Tuya Smart App..... 10
- 5. Maintenance..... 14**
- 6. Packing / Return..... 15**
  - 6.1. Packing Device in Transit / Shipment..... 15
- 7. Recycling..... 16**
- 8. Warranty..... 17**

Thank you for purchasing AGRG® EYWA® device. We are making continuous efforts to produce the highest quality products and we hope that you will enjoy our devices. We strive to ensure that AGRG® EYWA® products will serve you for many years, so please read this manual carefully before installing and operating.

With gratitude and appreciation,

*Yours,*  
AGRG

# 1. About the Manual



**Additional accessories and functions may not be available at the time of the document release. Their appearance will be announced on the official websites of the manufacturer.**

## 1.1. The Term of the Manual

This document is valid until a new version is published in the appropriate section on <https://agrg.design>.

## 1.2. Content and Purpose of the Document

The content of the document is limited to the description of assembly, installation, commissioning and basic usage of the product.

## 2. Basic Safety Instructions

The product is manufactured according to modern standards and safety regulations. The product design meets the requirements of fire and electrical safety. However, during its usage, dangerous situations can arise for people and property.



**Please read and observe the following safety precautions before using the product.**

### 2.1. Target Purpose

This product is intended only for the purposes given and described in the "Product Description" section. Any other use is considered as improper use. The manufacturer is not liable for any damage or injury caused by improper use. The user/operator of the product is the only person bearing the risks of misuse.

### 2.2. Assembly and Installation

Check the device for visible damage after transportation or improper storage. Do not switch on the device if it is damaged!

The product should be installed only in places that comply with the environmental and technical conditions specified by the manufacturer.

The manufacturer is not be liable for damage caused by improper handling or installation.

### 2.3. Service and Maintenance

Transformation, modification, repair and maintenance of the product can only be performed by qualified specialists. The manufacturer accepts no liability resulting from any changes and modifications carried out by the other persons.

### 2.4. Accessories and Spare Parts

Accessories and spare parts shall meet the specifications of the manufacturer. The product warranty remains only if original accessories and spare parts manufactured by AGRG are used.

### 2.5. Environment Protection

Recycling of household waste device is prohibited. Used devices contain valuable materials that must be recycled. End-of-life devices should be disposed of properly.



### 3. Product Description

#### 3.1. Overview

BeeSwitch (Sensor Wireless Scene Switch) is a low power electronic device designed to control scenes in the Tuya IoT system. For communication and interaction, the device uses Zigbee technology, so a Zigbee gateway is required for operation. The device is powered by a single CR2450 battery.

Depending on model, BeeSwitch can have either one or two sensor keys for controlling other smart devices.

On the front side, the device has a red color LED indication of events. The device has the stand-by flickering function with a blue LED, which can be turned off by a toggle on the rear side.

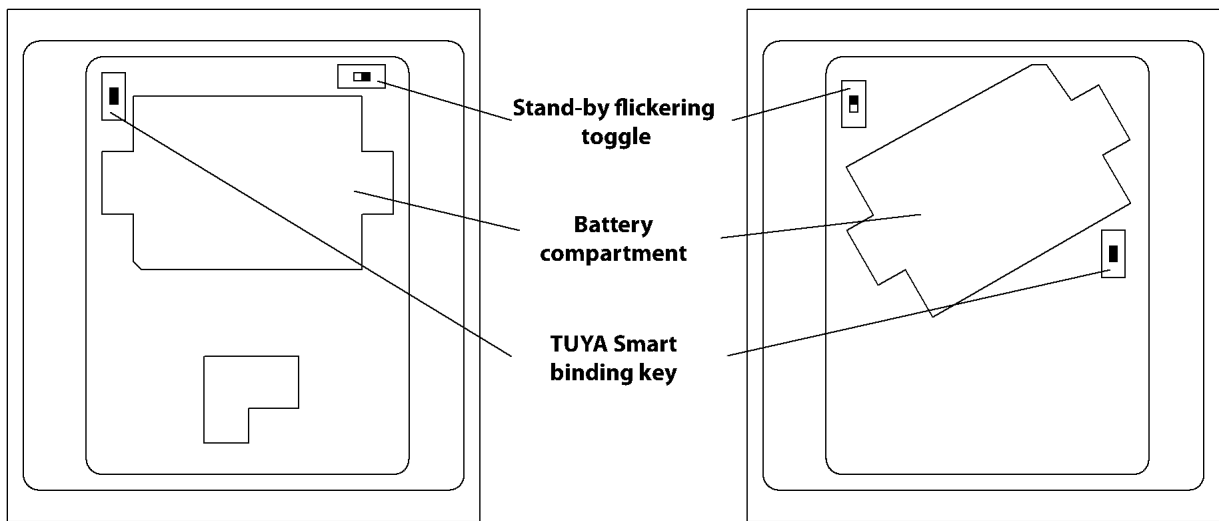

**BeeSwitch two key (left) and one key (right) models. Rear view diagram**

The device is designed for indoor installation and continuous round-the-clock operation.

#### 3.2. Mounting

The device is mounted on a flat surface using a special mounting plate and magnets included in the box.

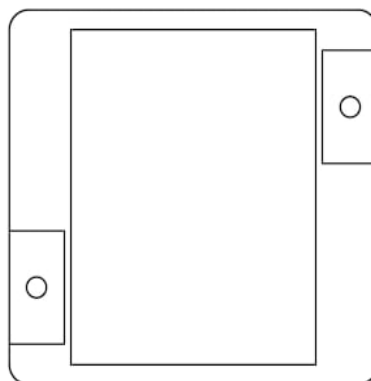

The magnets are installed in the grooves on the mounting plate and are screwed to the surface through a common hole. After that, the device can be fixed on the surface thanks to the magnets.

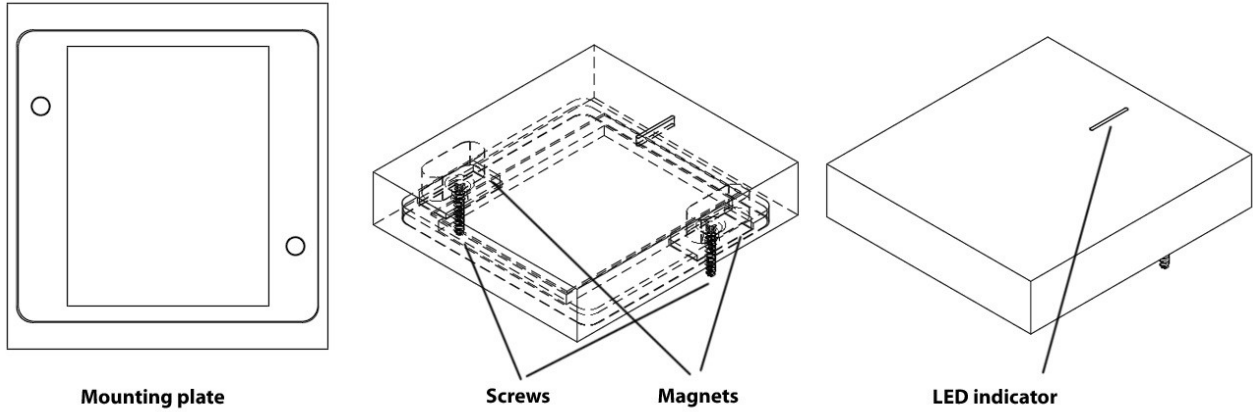

**BeeSwitch is recommended to be installed in such a way that the distance between the device and the permanent location of the user is at least 20 cm.**

### 3.3. Operation Principle

During operation, the device continuously measures the electrical capacity of the electrode, which is arranged underneath the front surface. When a hand approaches or touches the front surface of the device, the measured electrical capacitance changes and the device's touch key triggers the action.

### 3.4. Technical Specifications

Battery type	CR2450 (3V)
Battery life	Approx. 1 year
Radio protocol	Zigbee 3.0
Zigbee connectivity	<p>Support 802.15.4 MAC/PHY</p> <p>Working channels 11 to 26 @2.400 to 2.483 GHz, air interface rate: 250 Kbps</p> <p>Up to +10dBm output power and dynamic output power &gt; 35 dB</p> <p>Built-in onboard PCB antenna</p> <p>Onboard PCB antenna with a gain of 1.08 dBi</p> <p>Support hardware encryption and AES 128</p>
Tuya Smart scene support	<p>3 scenes (one key BeeSwitch)</p> <p>6 scenes (two key BeeSwitch)</p>

Range	Up to 35 m
Operating temperature	0°C...+40°C
Relative humidity	0-95%, excluding condensation
Protection class according to BS EN 60529	IP54
Body material	Stabilized solid block of fine wood
Thermal expansion coefficient	$(1,0\pm 0,2)\cdot 10^{-6}$ 1/K
Reader Hardness by Shore D, (HDS)	$\geq 45$
Axial shear endurance limit	$\geq 5$ MPa ( $\geq 50$ kgs/cm <sup>2</sup> )
Size	60mm x 65mm x 13.5mm

### 3.5. What's in the Box

1	AGRG® EYWA® BeeSwitch	1 pc
2	Mounting plate	1 pc
3	Brief operation manual	1 pc
4	Screws/Dowels	2pc/2pc



## 4. Preparation for Work

### 4.1. Battery Installation

Before fixing the device at the surface, battery installation should be performed according to the figure below. You should hold the device by the side edges not touching the front of the device. Otherwise, the sensor sensitivity may not be correctly calibrated when turned on and the device's sensor may not work properly.

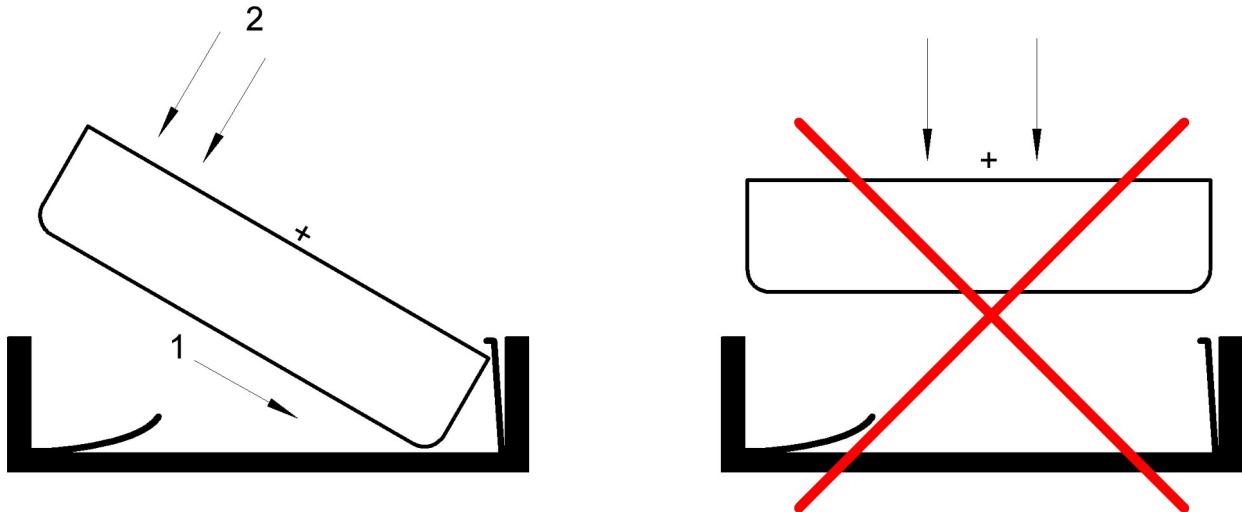

### 4.2. Binding to Zigbee Gateway

To control and configure BeeSwitch device, Tuya Smart App must be installed on your smartphone and a Zigbee gateway must be set up in your smart home environment.



Tuya Smart App

First, you have to bind your BeeSwitch to Zigbee gateway. To connect to Zigbee gateway, press and hold the binding key located on the back of BeeSwitch for about 10 seconds. The indicator on the front panel will start flashing blue. In Tuya Smart App select Zigbee gateway and press **Add Subdevice** button (the name may be different depending on gateway brand). After your BeeSwitch device is bound to a gateway, it will appear in Tuya Smart App.



**To change connection mode, you should press and hold binding key for 10 seconds again. The blinking frequency of the LED indicator will change.**



The connection quality and power consumption of the device depend directly on the distance to the Zigbee gateway. The greater the distance to the gateway, the more power will be spent on data transmission, and the faster the battery will drain.

Now you can fix BeeSwitch at the surface using magnets (see Mounting).

### 4.3. Device Configuration Using Tuya Smart App

To configure smart scenes open Tuya Smart App and find newly installed BeeSwitch device.

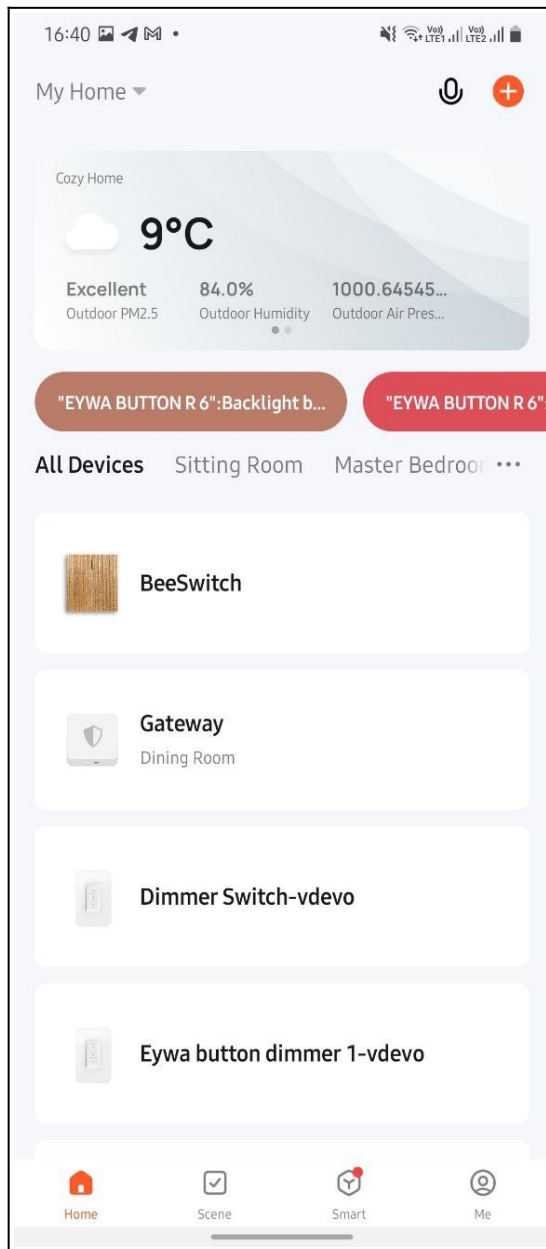

For a two key device, you should select which of the sensor keys you will configure first. Select either Switch 1 (left sensor key) or Switch 2 (right sensor key). For a single key device, only Switch 1 is available.

Click **Add intelligence** button. In the popup select any of three supported touch actions: single click, double click, or long press.

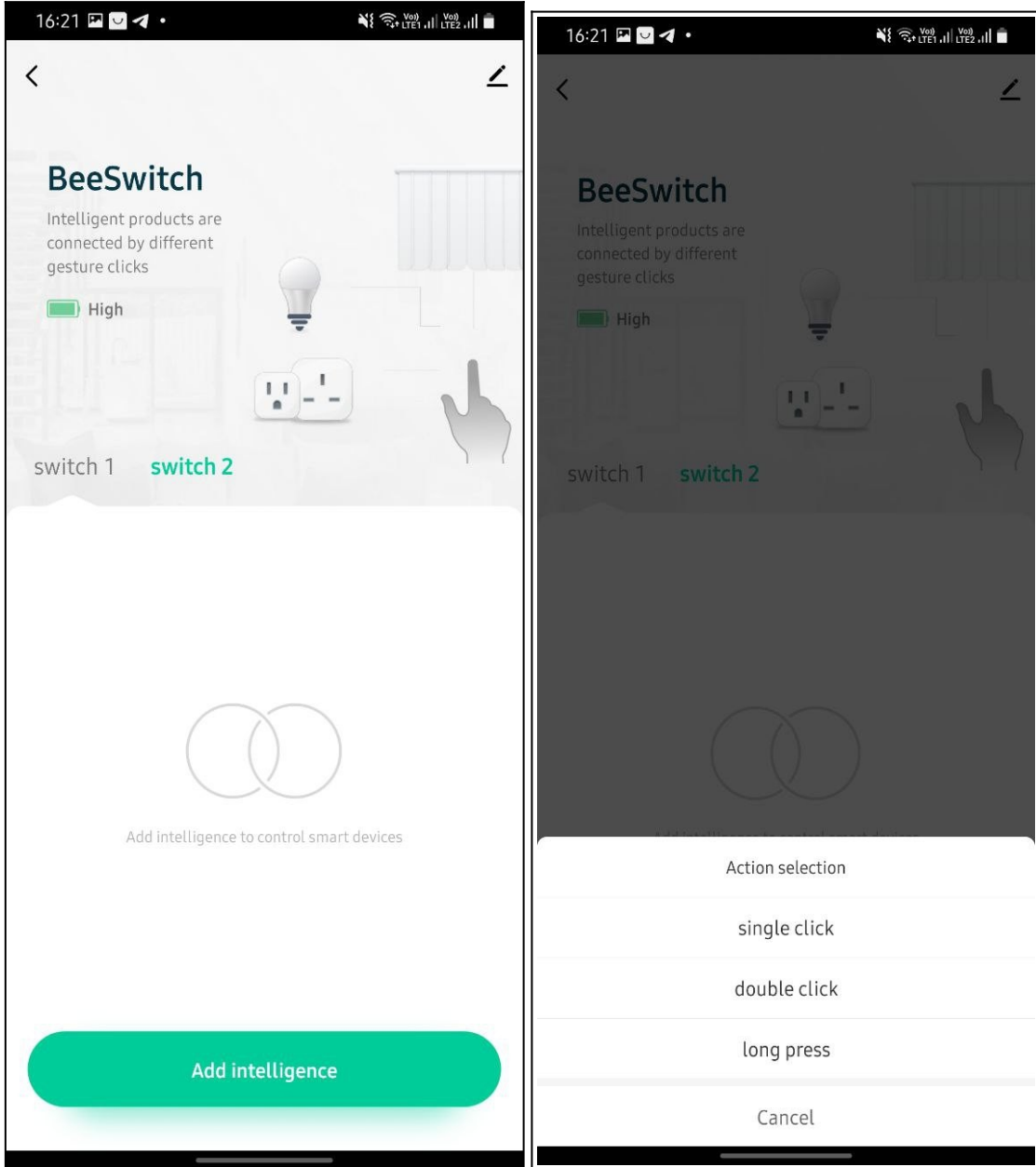

A **Create scene** screen will appear, where you need to create a new scene by adding **Tap-to-Run Task** and selecting any of the connected Tuya devices from the list.

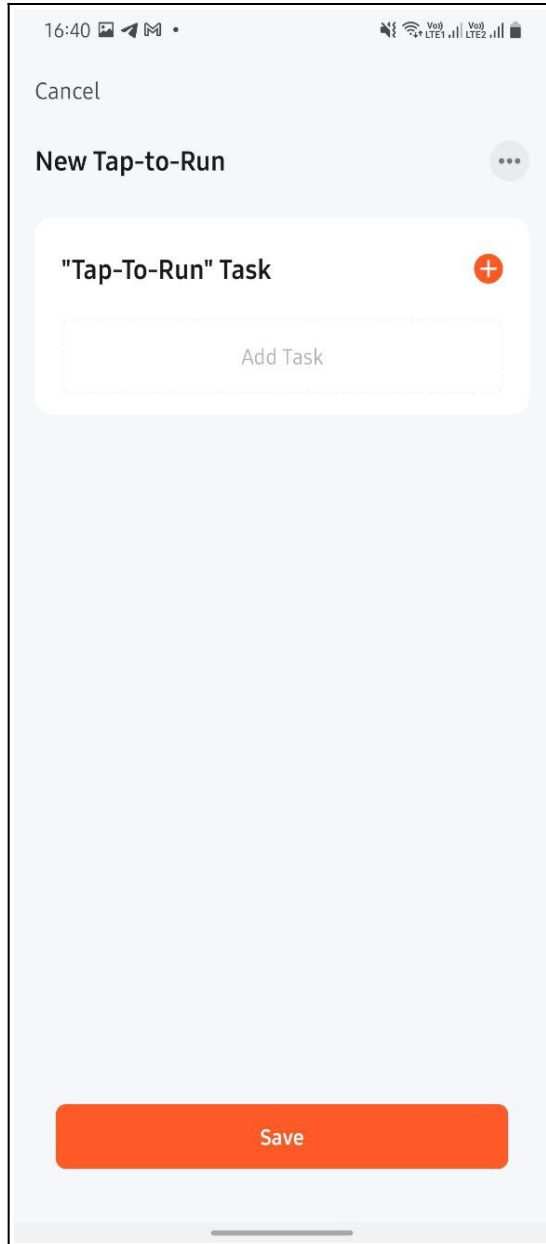

After a scene is configured, it will be executed when a user performs a respective (touch) action with BeeSwitch.

Return to the start screen and repeat the configuration of remaining actions according to your needs.

If you previously created smart scenes, they will also appear on the screen after clicking **Add intelligence** and selecting an action. Choose any of them from the list to assign an existing scene to an action.

Press **Save** in the upper right corner.

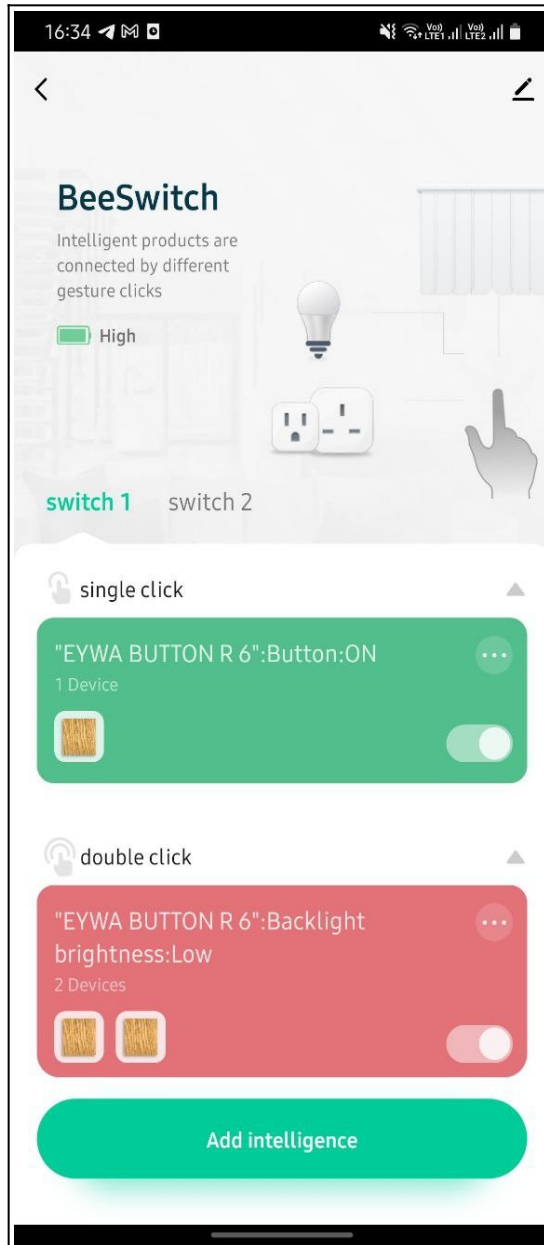

## 5. Maintenance

The device does not require maintenance. Its surface is cleaned with a dry soft cloth.

## 6. Packing / Return

Improper packaging of the device may result in additional costs due to transport damage. Please observe the following instructions when transporting/sending the reader. AGRG is not responsible for damage caused by improper packaging and transportation.

### 6.1. Packing Device in Transit / Shipment

The original package is specially made for the device. It protects optimally against damage during transport.

Always use the original packaging when returning products! If this is not possible, ensure that the packaging prevents any damage to the device:

- Use a sturdy box with thick walls or a box for transportation. The shipping box shall be large enough to leave a free space of 3-5 cm between the device and the wall of the container.
- Wrap the device in a suitable wrap or place it in a package.
- Cover the device tightly with foam pads or, for example, air bags. The device shall not be able to move inside the package.
- Use an environmentally friendly, dust-free filler.

## 7. Recycling

Disposal of the device with household waste is not permitted.

The internal components of the device must be separated before disposal or reuse. Old and used devices contain valuable recyclable materials that must be disposed.



The body of the device is made of environmental materials and must be recycled properly. Recycle package in environmentally friendly manner.



Packaging materials are recyclable. Do not dispose of package with household waste; take it to a recycling center instead.



## 8. Warranty

1. AGRG provides a limited one-year warranty for the device, which is a voluntary manufacturer's warranty. It provides rights regardless of the rights established by Consumer Protection Act, including, but not limited to, the rights regarding non-compliant products.



**FULL TERMS OF LIMITED ANNUAL WARRANTY ARE SPECIFIED ON AGRG EYWA [HTTPS://AGRG.DESIGN/EN/PARTNERS/WARRANTY](https://agrg.design/en/partners/warranty) IN «LEGAL INFORMATION» SECTION.**

2. All AGRG® EYWA® devices have a unique digital code by which one could define a warranty period. The warranty check, for users anywhere in the world at any time, excludes the risk of loss, forgetting, non-completing or falsifying of physical warranty cards.
3. The warranty check is available on the Internet at [HTTPS://AGRG.DESIGN/EN/PARTNERS/WARRANTY](https://agrg.design/en/partners/warranty). To check, you must enter the unique digital code of the device in a special field and click the "Validate" button. The verification process is carried out using Waves blockchain technology, which confirms the authenticity of the warranty certificate and excludes the possibility of falsification. All warranty information is placed on the Waves blockchain and is not stored anywhere on the servers of AGRG.
4. AGRG does not collect customer data. The warranty is not tied to the name or any other data of the owner (mail, company, address, etc.).
5. **AGRG disclaims responsibility for possible harm directly or indirectly caused by the products of AGRG to people, pets, property, if this happened as a result of non-observance of the rules of operation, installation of the device, intentional or careless actions of the consumer or third parties.**



1142, Sofia, Bulgaria  
Bul. Vasil Levski 73

E-mail: [info@agrg.design](mailto:info@agrg.design)  
Web: [agrg.design](http://agrg.design)